

# DATA SHEET

Part No.	AN44065A
Package Code No.	HSOP042-P-0400D

---

## Contents

■ Overview .....	3
■ Features .....	3
■ Applications .....	3
■ Package .....	3
■ Type .....	3
■ Application Circuit Example (Block Diagram) .....	4
■ Pin Descriptions .....	5
■ Absolute Maximum Ratings .....	6
■ Operating Supply Voltage Range .....	6
■ Electrical Characteristics .....	7
■ Electrical Characteristics (Reference values for design) .....	9
■ Technical Data .....	10
■ Usage Notes .....	20

# AN44065A

## Driver IC for Stepping Motor

### ■ Overview

AN44065A is a two channels H-bridge driver IC. Bipolar stepping motor can be controlled by a single driver IC. 2-phase, 1-2 (type 2) phase, W1-2 phase can be selected.

### ■ Features

- 4-phase input (W 1- and 2-phase excitation enabled; exclusive OR function incorporated for simultaneous-ON prevention)
- Built-in CR chopping (with frequency selected)
- Built-in thermal protection and low voltage detection circuit
- Built-in 5-V power supply

### ■ Applications

- IC for stepping motor drives

### ■ Package

- 28 pin plastic small outline package with heat sink (SOP type)

### ■ Type

- Silicon monolithic IC

■ Application Circuit Example

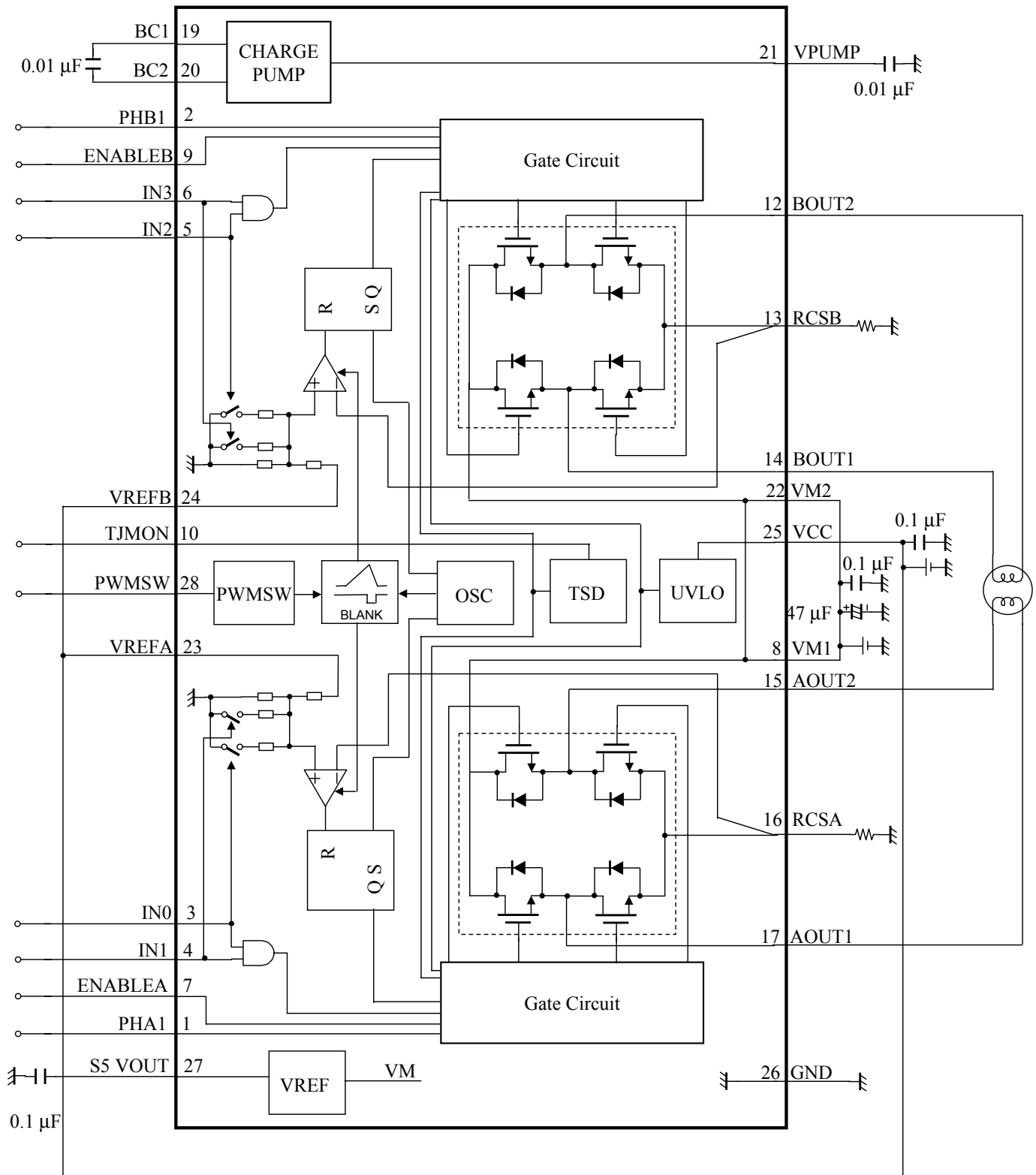

## ■ Pin Descriptions

Pin No.	Pin name	Type	Description
1	PHA1	Input	Phase A phase selection input
2	PHB1	Input	Phase B phase selection input
3	IN0	Input	Phase A output torque control 1
4	IN1	Input	Phase A output torque control 2
5	IN2	Input	Phase B output torque control 1
6	IN3	Input	Phase B output torque control 2
7	ENABLEA	Input	Phase A Enable/Disable CTL
8	VM1	Power supply	Motor power supply 1
9	ENABLEB	Input	Phase B Enable/Disable CTL
10	TJMON	Output	VBE monitor use
11	N.C.	—	—
12	BOUT2	Output	Phase B motor drive output 2
13	RCSB	Input / Output	Phase B current detection
14	BOUT1	Output	Phase B motor drive output 1
15	AOUT2	Output	Phase A motor drive output 2
16	RCSA	Input / Output	Phase A current detection
17	AOUT1	Output	Phase A motor drive output 1
18	N.C	—	—
19	BC1	Output	Charge Pump capacitor connection 1
20	BC2	Output	Charge Pump capacitor connection 2
21	VPUMP	Output	Charge Pump circuit output
22	VM2	Power supply	Motor power supply 2
23	VREFA	Input	Phase A torque reference voltage input
24	VREFB	Input	Phase B torque reference voltage input
25	VCC	Power supply	Signal power supply
26	GND	Ground	Signal ground
27	S5 VOUT	Output	Internal reference voltage (5-V output)
28	PWMSW	Input	PWM frequency selection input
FIN	FIN	earth	—

### ■ Absolute Maximum Ratings

A No.	Parameter	Symbol	Rating	Unit	Note
1	Supply voltage1 (Pin 8, Pin 22)	VM	30	V	*1
2	Supply voltage2 (Pin 25)	VCC	-0.3 to +6	V	*1
3	Power dissipation	$P_D$	0.717	W	*2
4	Operating ambient temperature	$T_{opr}$	-20 to +70	°C	*3
5	Storage temperature	$T_{stg}$	-55 to +150	°C	*3
6	Output pin voltage (Pin 12, Pin 14, Pin 15, Pin 17)	$V_{OUT}$	30	V	*1
7	Motor drive current (Pin 12, Pin 14, Pin 15, Pin 17)	$I_{OUT}$	$\pm 1.5$	A	*1
8	Flywheel diode current (Pin 12, Pin 14, Pin 15, Pin 17)	$I_f$	1.5	A	*1

Note) \*1: Do not apply current or voltage from outside to any pin not listed above.

In the circuit current, (+) means the current flowing into IC and (-) means the current flowing out of IC.

\*2: The power dissipation shown is the value in free-air for the independent IC package.

When using this IC, refer to the  $\bullet P_D - T_a$  diagram in the ■ Technical Data and use under the condition not exceeding the allowable value.

\*3: Except for the storage temperature, operating ambient temperature, and power dissipation all ratings are for  $T_a = 25^\circ\text{C}$ .

### ■ Operating Supply Voltage Range

Parameter	Symbol	Range	Unit	Note
Operating supply voltage range1	VM	18.0 to 28.0	V	—
Operating supply voltage range2	VCC	4.5 to 5.5	V	—

Note) The values under the condition not exceeding the above absolute maximum ratings and the power dissipation.

### ■ Electrical Characteristics at $V_M = 24\text{ V}$ , $V_{CC} = 5\text{ V}$

Note)  $T_a = 25^\circ\text{C} \pm 2^\circ\text{C}$  unless otherwise specified.

B No.	Parameter	Symbol	Conditions	Limits			Unit	Note
				Min	Typ	Max		
<b>Output Drivers</b>								
1	High-level output saturation voltage	$V_{OH}$	$I = -1.0\text{ A}$	$V_M - 0.75$	$V_M - 0.5$	—	V	—
2	Low-level output saturation voltage	$V_{OL}$	$I = 1.0\text{ A}$	—	0.55	0.825	V	—
3	Flywheel diode forward voltage	$V_{DI}$	$I = 1.0\text{ A}$	0.5	1.0	1.5	V	—
4	Output leakage current 1	$I_{LEAK1}$	$V_{OUT} = 30\text{ V}$ , $V_{RCS} = 0\text{ V}$	—	10	50	$\mu\text{A}$	—
5	Supply current (with two circuits turned off)	$I_M$	$ENABLEA = ENABLEB = 5\text{ V}$	—	3.7	5.7	mA	—
<b>I/O Block</b>								
6	Supply current	$I_{CC}$	$ENABLEA = ENABLEB = 5\text{ V}$	—	1.4	2.2	mA	—
7	High-level IN input voltage	$V_{INH}$	—	2.2	—	VCC	V	—
8	Low-level IN input voltage	$V_{INL}$	—	GND	—	0.6	V	—
9	High-level IN input current	$I_{INH}$	$IN0 = IN1 = IN2 = IN3 = 5\text{ V}$	-10	—	10	$\mu\text{A}$	—
10	Low-level IN input current	$I_{INL}$	$IN0 = IN1 = IN2 = IN3 = 0\text{ V}$	-15	—	15	$\mu\text{A}$	—
11	High-level PHA1/PHB1 input voltage	$V_{PHAH}$ $V_{PHBH}$	—	2.2	—	VCC	V	—
12	Low-level PHA1/PHB1 input voltage	$V_{PHAL}$ $V_{PHBL}$	—	GND	—	0.6	V	—
13	High-level PHA1/PHB1 input current	$I_{PHAH}$ $I_{PHBH}$	$PHA1 = PHB1 = 5\text{ V}$	25	50	100	$\mu\text{A}$	—
14	Low-level PHA1/PHB1 input current	$I_{PHAL}$ $I_{PHBL}$	$PHA1 = PHB1 = 0\text{ V}$	-15	—	15	$\mu\text{A}$	—
15	High-level ENABLEA/ENABLEB input voltage	$V_{ENABLEAH}$ $V_{ENABLEBH}$	—	2.2	—	VCC	V	—
16	Low-level ENABLEA/ENABLEB input voltage	$V_{ENABLEAL}$ $V_{ENABLEBL}$	—	GND	—	0.6	V	—
17	High-level ENABLEA/ENABLEB input current	$I_{ENABLEAH}$ $I_{ENABLEBH}$	$ENABLEA = ENABLEB = 5\text{ V}$	-10	—	10	$\mu\text{A}$	—
18	Low-level ENABLEA/ENABLEB input current	$I_{ENABLEAL}$ $I_{ENABLEBL}$	$ENABLEA = ENABLEB = 0\text{ V}$	-15	—	15	$\mu\text{A}$	—
19	High-level PWMSW input voltage	$V_{PWMSWH}$	—	2.2	—	VCC	V	—
20	Low-level PWMSW input voltage	$V_{PWMSWL}$	—	GND	—	0.6	V	—
21	High-level PWMSW input current	$I_{PWMSWH}$	$PWMSW = 5\text{ V}$	25	50	100	$\mu\text{A}$	—
22	Low-level PWMSW input current	$I_{PWMSWL}$	$PWMSW = 0\text{ V}$	-15	—	15	$\mu\text{A}$	—

■ Electrical Characteristics at VM = 24 V, VCC = 5 V (continued)

Note)  $T_a = 25^{\circ}\text{C} \pm 2^{\circ}\text{C}$  unless otherwise specified.

B No.	Parameter	Symbol	Conditions	Limits			Unit	Note
				Min	Typ	Max		
Torque Control Block								
23	Input bias current	$I_{\text{REFA}}$ $I_{\text{REFB}}$	$V_{\text{REFA}} = V_{\text{REFB}} = 5 \text{ V}$	70	99.5	130	$\mu\text{A}$	—
24	PWM frequency 1	$f_{\text{PWM1}}$	$\text{PWMSW} = 0 \text{ V}$	38	58	78	kHz	—
25	PWM frequency 2	$f_{\text{PWM2}}$	$\text{PWMSW} = 5 \text{ V}$	19	29	39	kHz	—
26	Pulse blanking time	$T_{\text{B}}$	$V_{\text{REFA}} = V_{\text{REFB}} = 0 \text{ V}$	0.6	1.2	1.8	$\mu\text{s}$	—
27	Cmp threshold H (100%)	$V_{\text{TH}}$	$\text{IN0} = \text{IN1} = 0 \text{ V}$ $\text{IN2} = \text{IN3} = 0 \text{ V}$	479	503	528	mV	—
28	Cmp threshold C (67%)	$V_{\text{TC}}$	$\text{IN0} = 5 \text{ V}, \text{IN1} = 0 \text{ V}$ $\text{IN2} = 5 \text{ V}, \text{IN3} = 0 \text{ V}$	308	333	359	mV	—
29	Cmp threshold L (33%)	$V_{\text{TL}}$	$\text{IN0} = 0 \text{ V}, \text{IN1} = 5 \text{ V}$ $\text{IN2} = 0 \text{ V}, \text{IN3} = 5 \text{ V}$	151	167	184	mV	—
Reference Voltage Block								
30	Reference voltage	$V_{\text{SS VOUT}}$	$\text{VM} = 24 \text{ V}, I_{\text{SS VOUT}} = -2.5 \text{ mA}$	4.5	5.0	5.5	V	—
31	Output impedance	$Z_{\text{SS VOUT}}$	$\text{VM} = 24 \text{ V}, I_{\text{SS VOUT}} = -5 \text{ mA}$	—	14	21	$\Omega$	—



■ Electrical Characteristics (Reference values for design) at  $V_M = 24\text{ V}$ ,  $V_{CC} = 5\text{ V}$

Note)  $T_a = 25^\circ\text{C} \pm 2^\circ\text{C}$  unless otherwise specified.

B No.	Parameter	Symbol	Test circuits	Conditions	Reference			Unit	Note
					Min	Typ	Max		
<b>Output Drivers</b>									
32	Output slew rate 1	$VT_r$	—	Rising edge	—	240	—	V/ $\mu\text{s}$	—
33	Output slew rate 2	$VT_f$	—	Falling edge	—	240	—	V/ $\mu\text{s}$	—
34	Dead time	$T_D$	—	—	—	2.2	—	$\mu\text{s}$	—
<b>Thermal Protection</b>									
35	Thermal protection operating temperature	$TSD_{on}$	—	—	—	155	—	$^\circ\text{C}$	—
36	Thermal protection hysteresis width	$\Delta TSD$	—	—	—	45	—	$^\circ\text{C}$	—

Note) The above characteristics are reference values for design of the IC and are not guaranteed by inspection.

If a problem does occur related to these characteristics, Panasonic will respond in good faith to user concerns.

■ Technical Data

- I/O block circuit diagrams and pin function descriptions

Note) The characteristics listed below are reference values based on the IC design and are not guaranteed.

Pin No.	Waveform and voltage	Internal circuit	Impedance	Description
1 2 28	—	<p>Pin 1 PHA1 2 PHB1 28 PWMSW</p>	100k	Pin1: Phase A phase selection input 2: Phase B phase selection input 28: PWM frequency selection input
3 4 5 6 7 9	—	<p>Pin 3 IN0 4 IN1 5 IN2 6 IN3 7 ENABLEA 9 ENABLEB</p>	—	Pin3: Phase A output torque control 1 4: Phase A output torque control 2 5: Phase B output torque control 1 6: Phase B output torque control 2 7: Phase A Enable/Disable CTL 9: Phase B Enable/Disable CTL
12 13 14	—	<p>Pin 12 BOUT2 14 BOUT1</p>	0.6	Pin12: Phase B motor drive output 2 13: Phase B current detection 14: Phase B motor drive output 1

### ■ Technical Data (continued)

- I/O block circuit diagrams and pin function descriptions (continued)

Note) The characteristics listed below are reference values based on the IC design and are not guaranteed.

Pin No.	Waveform and voltage	Internal circuit	Impedance	Description
15 16 17	—		0.6	Pin15: Phase A motor drive output 2 16: Phase A current detection 17: Phase A motor drive output 1
19	—		—	Pin19: Charge Pump capacitor connection 1
20 21	—		—	Pin20: Charge Pump capacitor connection 2 21: Charge Pump circuit output

### ■ Technical Data (continued)

#### • I/O block circuit diagrams and pin function descriptions (continued)





Note) The characteristics listed below are reference values based on the IC design and are not guaranteed.

Pin No.	Waveform and voltage	Internal circuit	Impedance	Description
23 24	—	<p>Pin 23 VREFA 24 VREFB</p>	50.25k	Pin23: Phase A torque reference voltage input 24: Phase B torque reference voltage input
10	—	<p>TJMON</p>	—	Pin10: VBE monitor use
27	—	<p>S5 VOUT</p>	14	Pin27: Internal reference voltage (5-V output)

■ Technical Data (continued)

- I/O block circuit diagrams and pin function descriptions (continued)

Note) The characteristics listed below are reference values based on the IC design and are not guaranteed.

Pin No.	Waveform and voltage	Internal circuit	Impedance	Description
Symbols	—	 VCC (Pin 25)  VM(Pin 8, Pin 22)  Diode  Zener diode  Ground (FIN)	—	—

■ Technical Data (continued)

• Control mode

1. Truth table

ENABLEA/ENABLEB	PHA1/PHB1	AOUT1/BOU1	AOUT2/BOU2
"L"	"H"	"H"	"L"
"L"	"L"	"L"	"H"
"H"	—	OFF	OFF

IN0/IN2	IN1/IN3	Output Current
"L"	"L"	$(V_{REF} / 10) \times (1 / R_{s*}) = I_{OUT}$
"H"	"L"	$(V_{REF} / 10) \times (1 / R_{s*}) \times (2 / 3) = I_{OUT}$
"L"	"H"	$(V_{REF} / 10) \times (1 / R_{s*}) \times (1 / 3) = I_{OUT}$
"H"	"H"	0

Note) 1. ENABLEA/ENABLEB = "H" or, IN0 = IN1 = "H"/IN2 = IN3 = "H", output = OFF

2.\*:  $R_s$ : current detection region

■ Technical Data (continued)

• Control mode (continued)

- 2. drive of full step (4steps sequence)  
(IN0 to IN3 = const.)

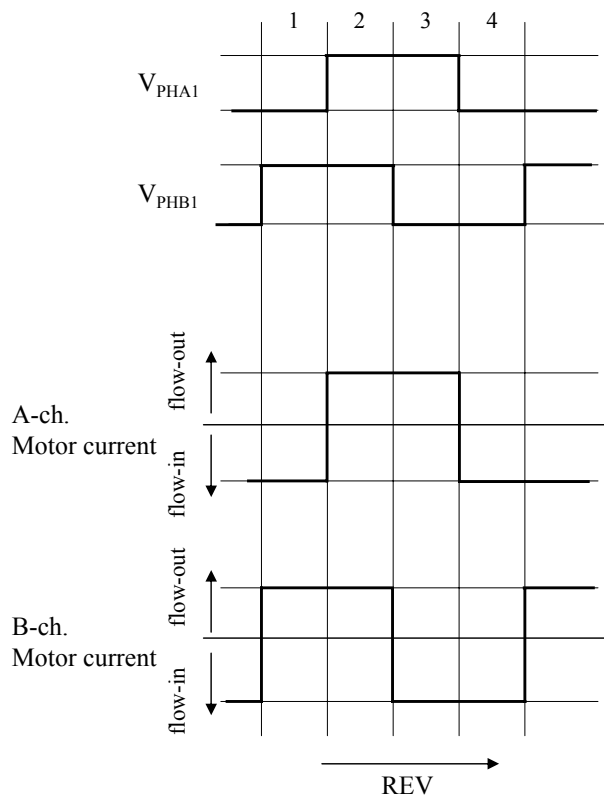
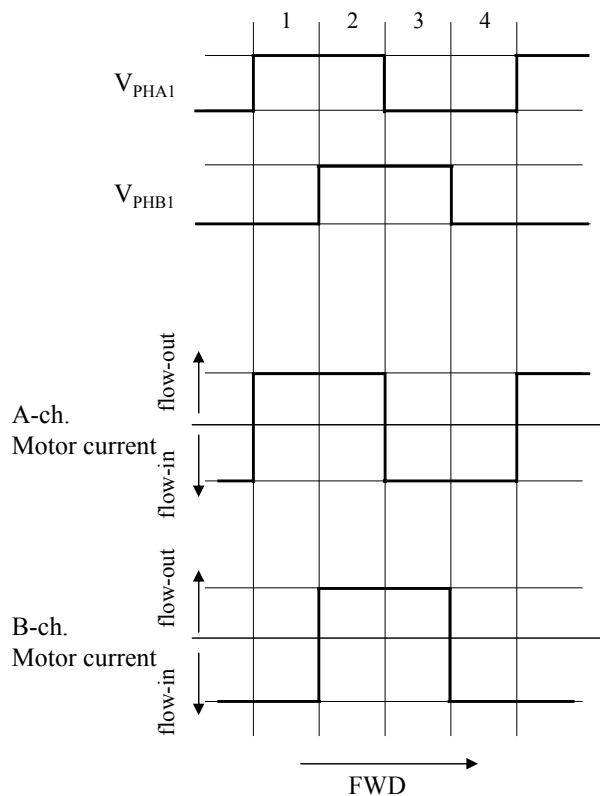

■ Technical Data (continued)

• Control mode (continued)

3. drive of half step (8 steps sequence)

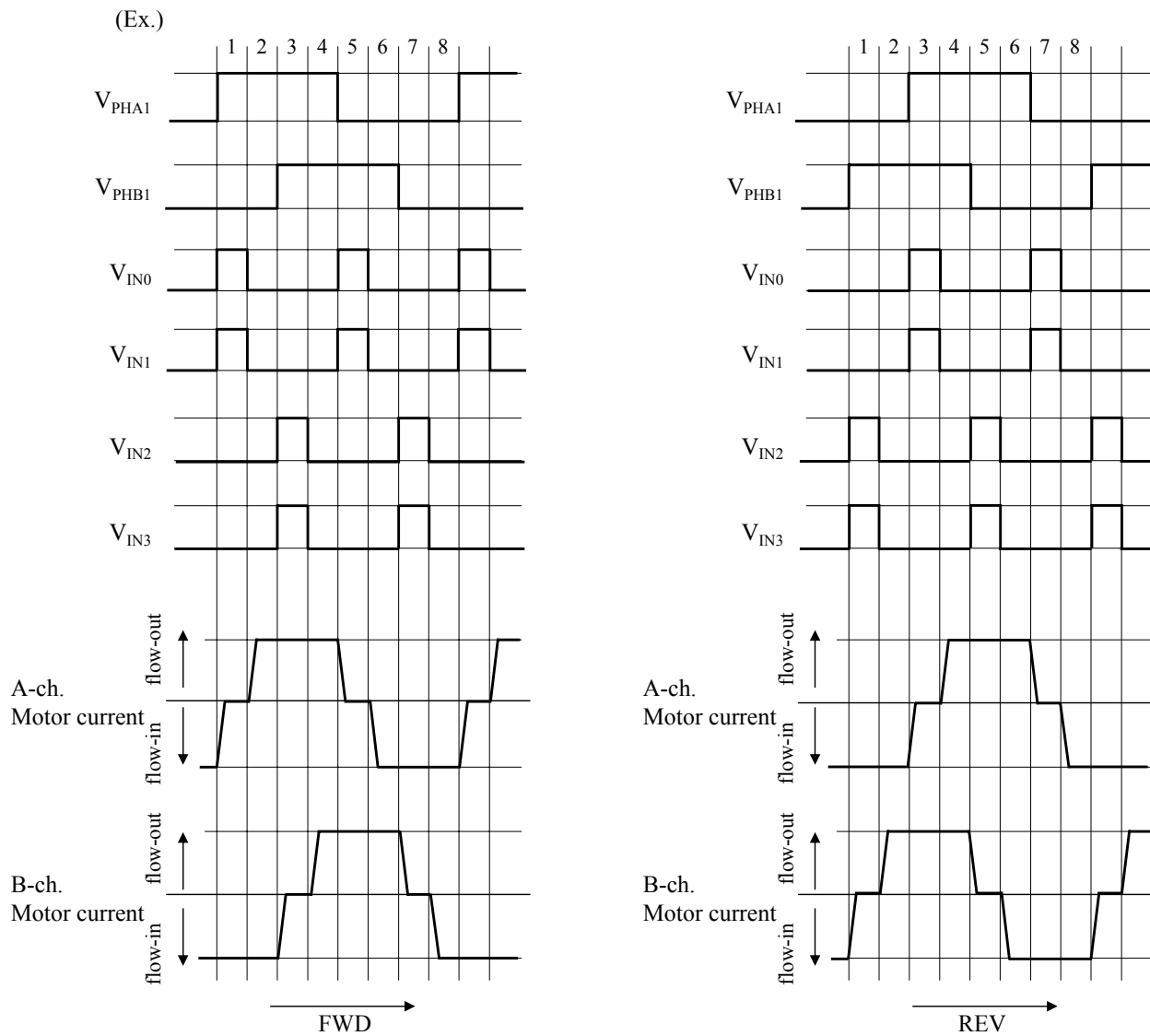



■ Technical Data (continued)

- Control mode (continued)

4. 1-2 phase excitation (8 steps sequence)

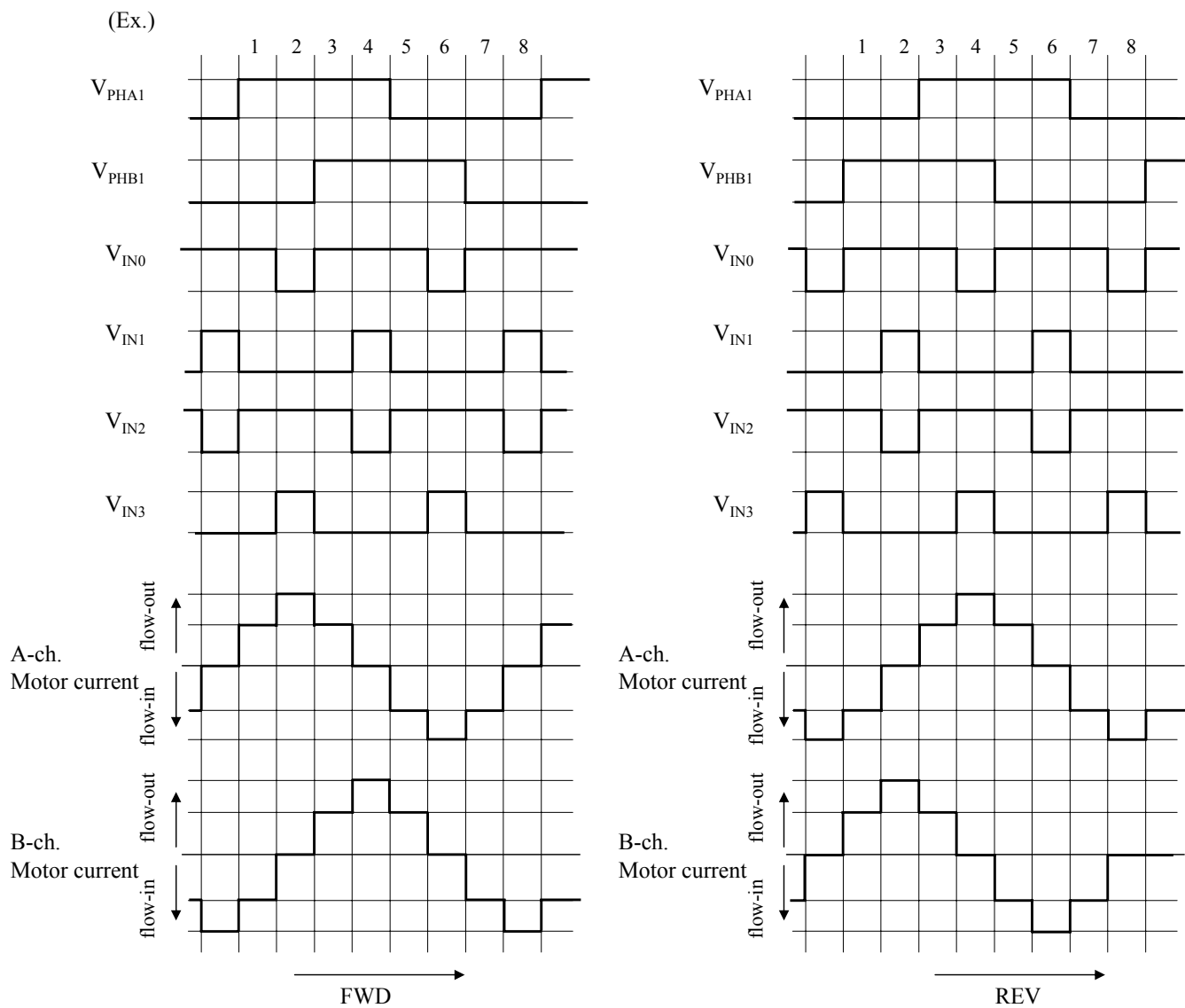

■ Technical Data (continued)

• Control mode (continued)

5. W1-2 phase excitation (16 steps sequence)

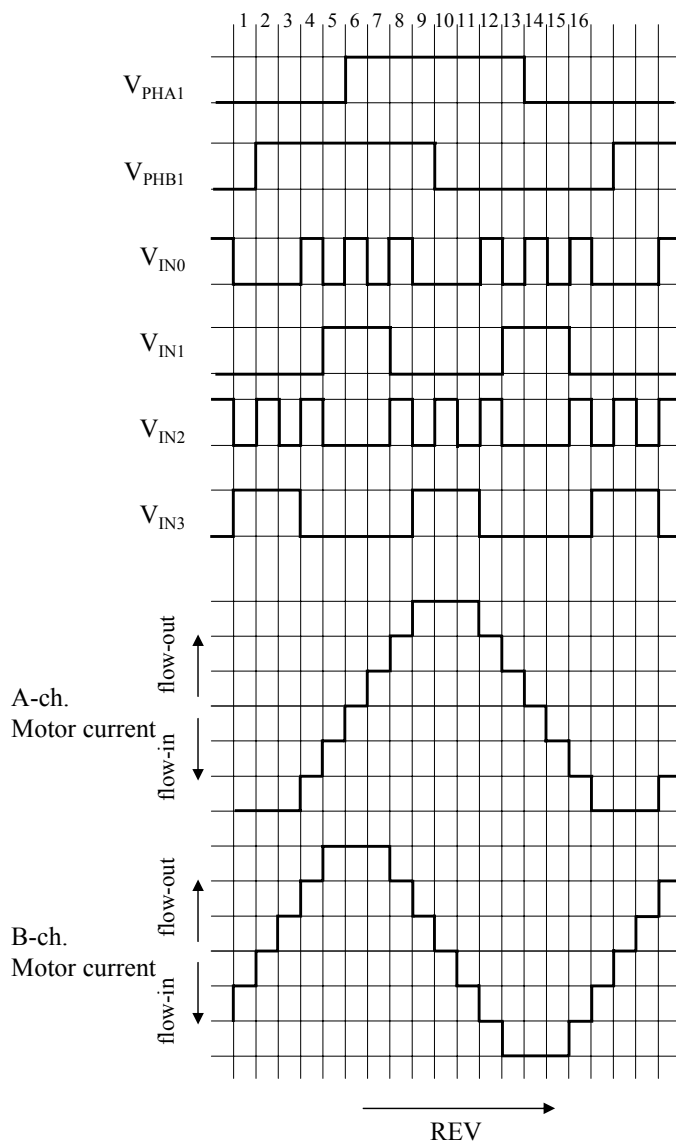
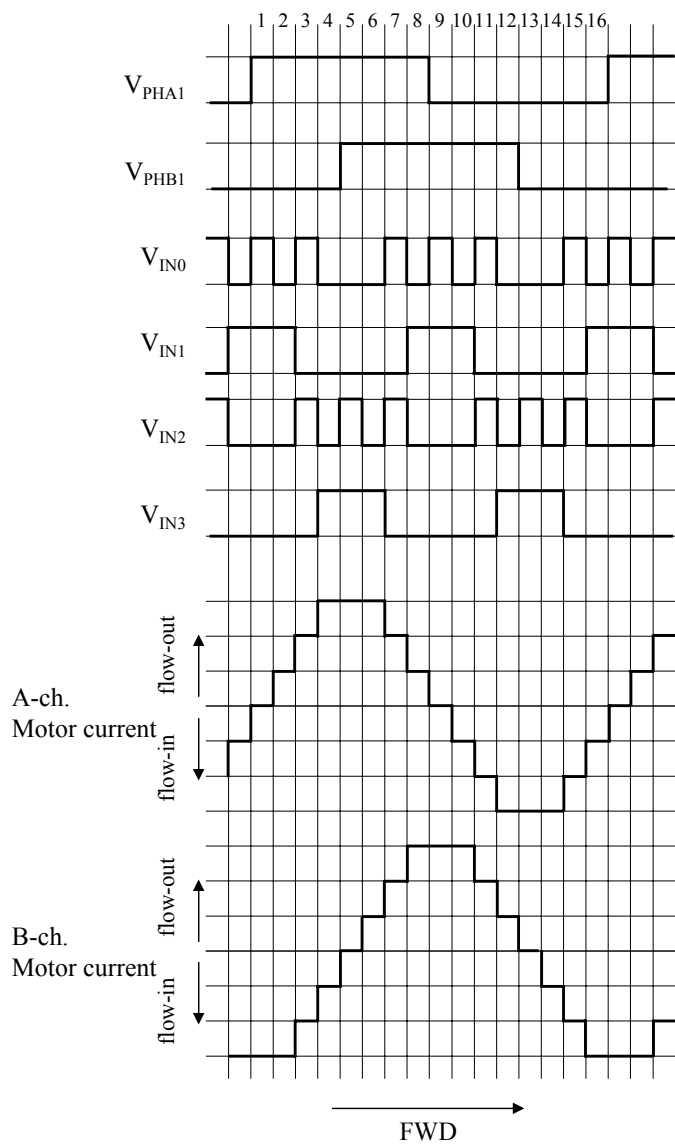

## ■ Technical Data (continued)

- $P_D$  —  $T_a$  diagram

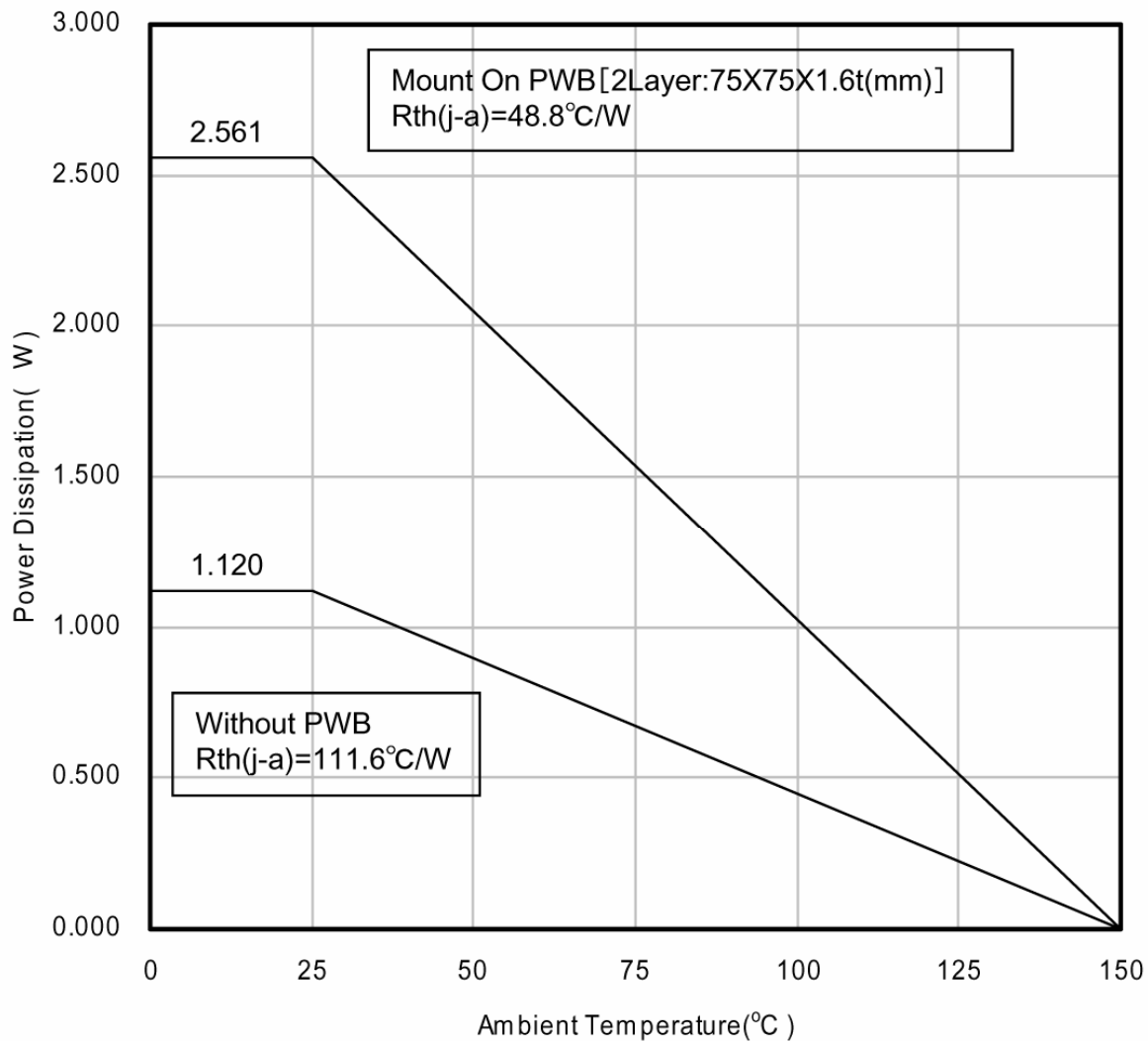

**■ Usage Notes**

1. Perform thermal design work with consideration of a sufficient margin to keep the power dissipation based on supply voltage, load, and ambient temperature conditions.  
(The IC is recommended that junctions are designed below 70% to 80% of Absolute Maximum Rating.)
2. The protection circuit is incorporated for the purpose of securing safety if the IC malfunctions.  
Therefore, design the protection circuit so that the protection circuit will not operate under normal operating conditions. The temperature protection circuit, in particular, may be destructed before the temperature protection circuit operates if the area of safety operation of the device or the maximum rating is exceeded instantaneously due to the short-circuiting between the output pin and VM pin or a ground fault caused by the output pin and ground pin.
3. Pay utmost attention to the pattern layout in order to prevent the IC from destruction resulting from the short-circuiting of pins. See **■ Pin Descriptions** for allocations of the pins of the IC.
4. When driving a motor coil or transformer (L) load, the device may be destructed as a result of a negative or excessive voltage generated at the time of turning the load on and off. Unless otherwise provided in the specifications, do not apply any negative or excessive voltage.
5. Do not make mistakes in the PCB mounting direction. If power is supplied with the pins mounted in the wrong direction, the IC may be destructed.
6. The IC may be destructed by the solder bridge between the pins of semiconductor devices. Fully make a visual check on the PCB before supplying power.  
Furthermore, the IC may be destructed if conductive foreign matters like solder chips are stuck to the IC during transportation after PCB mounting.  
Therefore, conduct full technical verification of the mounting quality of the IC.
7. The IC is destructed under an abnormal condition, such as the short-circuiting between the output and VM pins, output and ground pins, or output pins (i.e., load short-circuiting), in which case smoke may be generated. Pay utmost attention to the use of the IC.

Pay special attention to the following pins so that they are not short-circuited with the VM pin, ground pin, other output pin, or current detection pin.

- (1) AOUT1 (pin 17), AOUT2 (pin 15), BOUT1 (pin 14), BOUT2 (pin 12)
- (2) BC2 (pin 20), VPUMP (pin 21)
- (3) VM1 (pin 8), VM2 (pin 22), VREG (pin 25)
- (4) RCSA (pin 16), RCSB (pin 13)

The higher the current capacity of power supply is, the higher the possibility of the above destruction or smoke generation. Therefore, it is recommended to take safety countermeasures, such as the use of a fuse.

8. When using the IC for model expansion or new sets, be sure to make full safety checks including a long-term reliability check on each set.
9. Set the value of the capacitor between the VPUMP and GND pins so that the voltage on the VPUMP pin (pin 21) will not exceed 40 V in any case regardless of whether it is a transient phenomenon or not while the motor standing by is started.
10. This IC employs a PWM drive method that switches the high-current output of the output transistor. Therefore, the IC is apt to generate noise that may cause the IC to malfunction or have fatal damage. To prevent these problems, the power supply must be stable enough. Therefore, the capacitance between the VCC and GND pins must be a minimum of 0.1  $\mu\text{F}$  and the one between the VM and GND pins must be a minimum of 47  $\mu\text{F}$  and as close as possible to the IC so that PWM noise will not cause the IC to malfunction or have fatal damage.

### ■ Usage Notes (continued)

11. In order to prevent mistakes in current detection resulting noise, this IC is provided with a pulse blanking time of  $1.2 \mu\text{s}$  (typ.). The motor current will not be less than the current determined by blanking time. Pay utmost attention at the time of minute current control.

The graph on the right-hand side shows the relationship between the pulse blanking time and minute current value. The increase or decrease in the motor current is determined by the resistance of the internal winding of the motor.

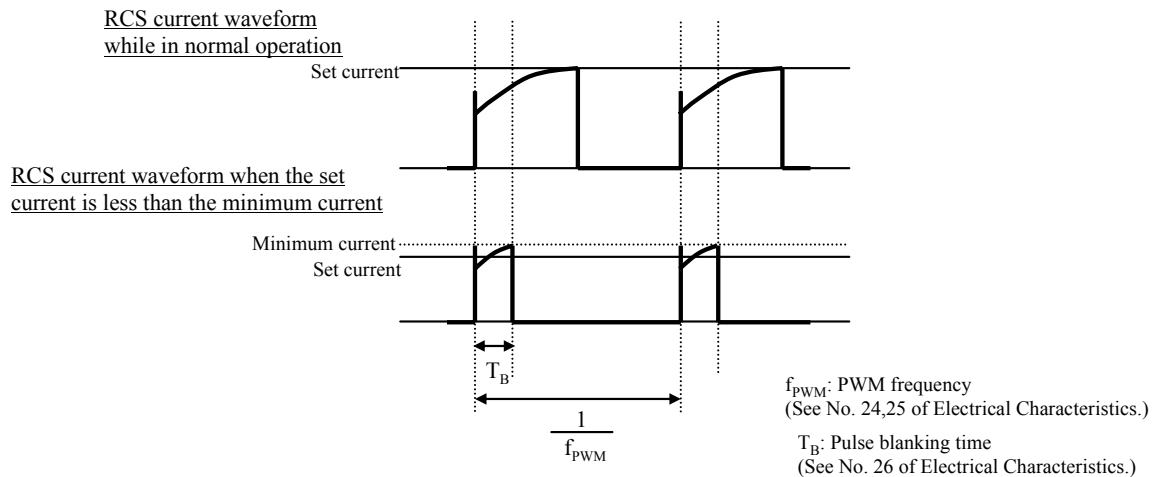

12. A high current flows into the IC. Therefore, the common impedance of the PCB pattern cannot be ignored. Take the following points into consideration and design the PCB pattern of the motor.

A high current flows into the line between the VM1 (pin 8) and VM2 (pin 22) pins. Therefore, noise is generated with ease at the time of switching due to the inductance ( $L$ ) of the line, which may result in the malfunctioning or destruction of the IC (see the circuit diagram on the left-hand side). As shown in the circuit diagram on the right-hand side, the escape way of the noise is secured by connecting a capacitor to the connector close to the VM pin of the IC. This makes it possible to suppress the direct VM pin voltage of the IC. Make the settings as shown in the circuit diagram on the right-hand side as much as possible.

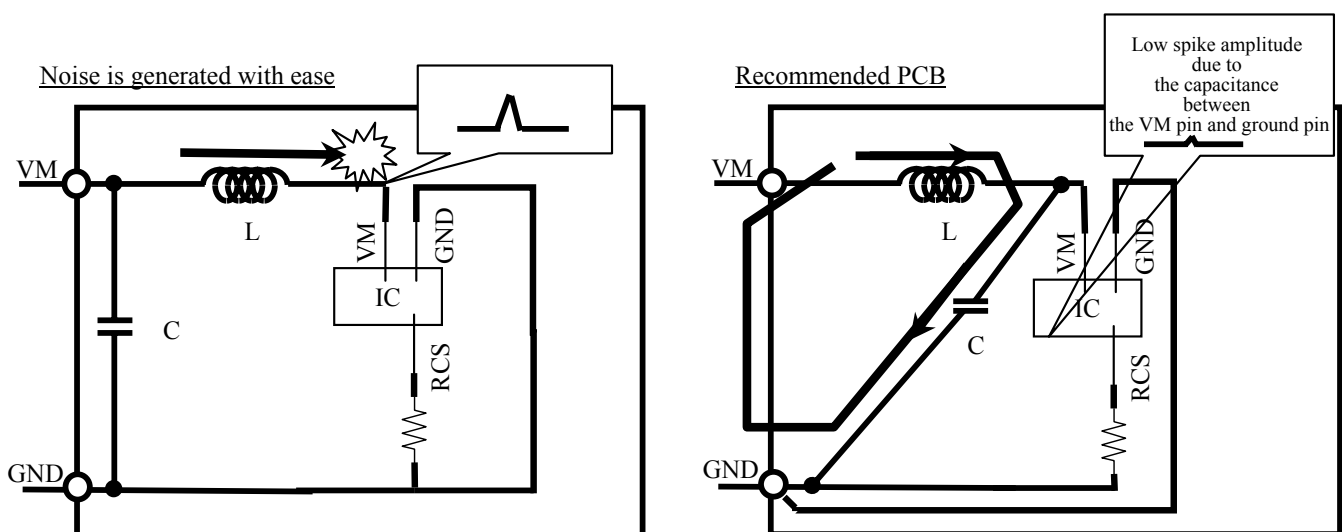

### ■ Usage Notes (continued)

13. In the case of measuring the chip temperature of the IC, measure the voltage of TJMON (pin 10) and presume chip temperature from following data. Use the following data as reference data. Before applying the IC to a product, conduct a sufficient reliability test of the IC along with the evaluation of the product with the IC incorporated.

The temperature characteristic of TJMON

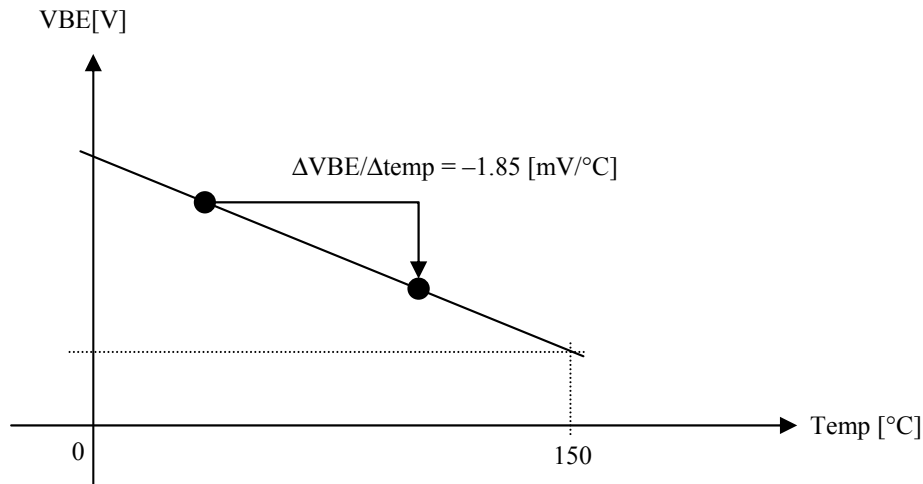

### 14. Power Supply Sequence

- If two types of power supply are used

Rise: This IC is recommended rise of 5 V power supply before rise of 24 V power supply.

Fall: Although there is no particular rule, check that VM fall time is about 1 sec.

When recommended sequence is difficult, take the diagram below indicates into consideration and design.

Also, rise slew rate design

VM: below  $0.1 \text{ V}/\mu\text{s}$ , VCC: below  $0.1 \text{ V}/\mu\text{s}$

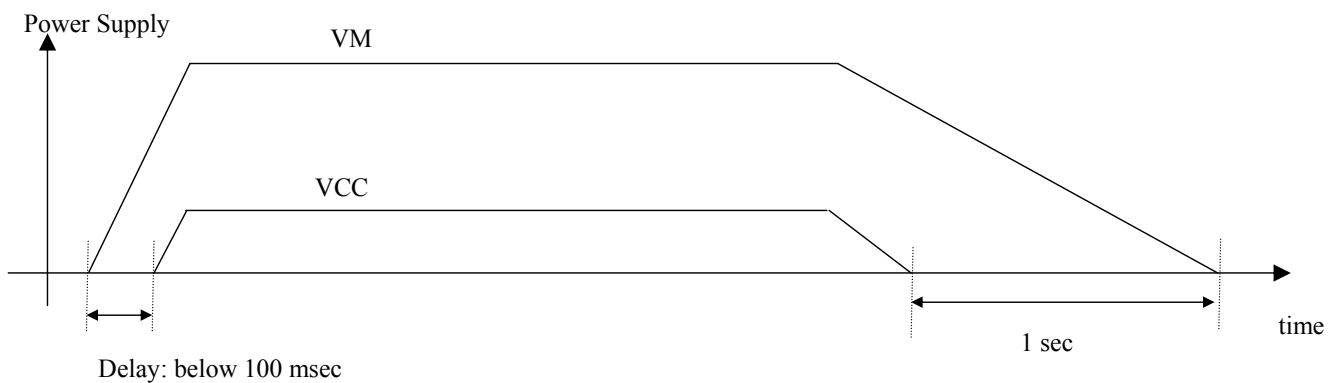

- If one type of power supply is used

Rise slew rate design

VM: below  $0.1 \text{ V}/\mu\text{s}$

15. Check the risk that is caused by the failure of external components.

## Request for your special attention and precautions in using the technical information and semiconductors described in this book

- (1) If any of the products or technical information described in this book is to be exported or provided to non-residents, the laws and regulations of the exporting country, especially, those with regard to security export control, must be observed.
- (2) The technical information described in this book is intended only to show the main characteristics and application circuit examples of the products. No license is granted in and to any intellectual property right or other right owned by Panasonic Corporation or any other company. Therefore, no responsibility is assumed by our company as to the infringement upon any such right owned by any other company which may arise as a result of the use of technical information described in this book.
- (3) The products described in this book are intended to be used for standard applications or general electronic equipment (such as office equipment, communications equipment, measuring instruments and household appliances).  
Consult our sales staff in advance for information on the following applications:
  - Special applications (such as for airplanes, aerospace, automobiles, traffic control equipment, combustion equipment, life support systems and safety devices) in which exceptional quality and reliability are required, or if the failure or malfunction of the products may directly jeopardize life or harm the human body.
  - Any applications other than the standard applications intended.
- (4) The products and product specifications described in this book are subject to change without notice for modification and/or improvement. At the final stage of your design, purchasing, or use of the products, therefore, ask for the most up-to-date Product Standards in advance to make sure that the latest specifications satisfy your requirements.
- (5) When designing your equipment, comply with the range of absolute maximum rating and the guaranteed operating conditions (operating power supply voltage and operating environment etc.). Especially, please be careful not to exceed the range of absolute maximum rating on the transient state, such as power-on, power-off and mode-switching. Otherwise, we will not be liable for any defect which may arise later in your equipment.
  - Even when the products are used within the guaranteed values, take into the consideration of incidence of break down and failure mode, possible to occur to semiconductor products. Measures on the systems such as redundant design, arresting the spread of fire or preventing glitch are recommended in order to prevent physical injury, fire, social damages, for example, by using the products.
- (6) Comply with the instructions for use in order to prevent breakdown and characteristics change due to external factors (ESD, EOS, thermal stress and mechanical stress) at the time of handling, mounting or at customer's process. When using products for which damp-proof packing is required, satisfy the conditions, such as shelf life and the elapsed time since first opening the packages.
- (7) This book may be not reprinted or reproduced whether wholly or partially, without the prior written permission of our company.